

KA431/KA431A/KA431L

Programmable Shunt Regulator

Features

- Programmable Output Voltage to 36 Volts
- Low Dynamic Output Impedance 0.20 Typical
- Sink Current Capability of 1.0 to 100mA
- Equivalent Full-Range Temperature Coefficient of 50ppm/°C Typical
- Temperature Compensated for Operation Over Full Rated Operating Temperature Range
- Low Output Noise Voltage
- Fast Turn-on Response

Description

The KA431/KA431A/KA431L are three-terminal adjustable regulator series with a guaranteed thermal stability over applicable temperature ranges. The output voltage may be set to any value between VREF (approximately 2.5 volts) and 36 volts with two external resistors. These devices have a typical dynamic output impedance of 0.2W active output circuitry provides a very sharp turn on characteristic, making these devices excellent replacement for zener diodes in many applications.

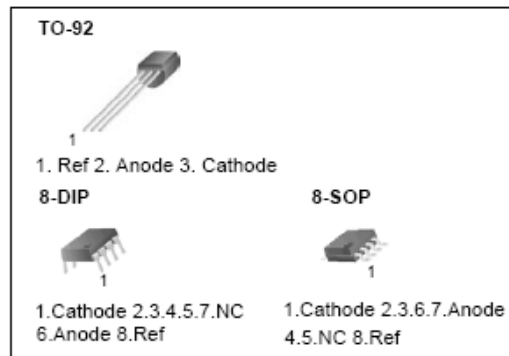

Internal Block Diagram

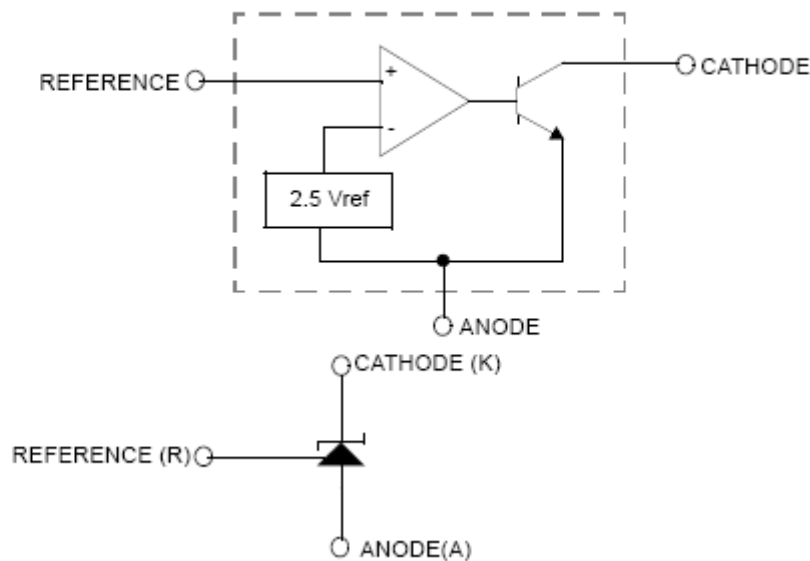

Absolute Maximum Ratings

(Operating temperature range applies unless otherwise specified.)

Parameter	Symbol	Value	Unit
Cathode Voltage	V_{KA}	37	V
Cathode Current Range (Continuous)	I_{KA}	-100 ~ +150	mA
Reference Input Current Range	I_{REF}	-0.05 ~ +10	mA
Power Dissipation D, Z Suffix Package DIP Package	P_D	770 1000	mW mW
Operating Temperature Range	T_{OPR}	-25 ~ +85	°C
Junction Temperature	T_J	150	°C
Storage Temperature Range	T_{STG}	-65 ~ +150	°C

Recommended Operating Conditions

Parameter	Symbol	Min.	Typ.	Max.	Unit
Cathode Voltage	V_{KA}	V_{REF}	-	36	V
Cathode Current	I_{KA}	1.0	-	100	mA

Electrical Characteristics

(TA = +25°C, unless otherwise specified)

Parameter	Symbol	Conditions	KA431			KA431A			KA431L			Unit	
			Min.	Typ.	Max.	Min.	Typ.	Max.	Min.	Typ.	Max.		
Reference Input Voltage	VREF	VKA=VREF, IKA=10mA	2.45	2.5	2.55	2.47	2.495	2.52	2.482	2.495	2.508	V	
Deviation of Reference Input Voltage Over-Temperature	$\Delta V_{REF}/\Delta T$	VKA=VREF, IKA=10mA TMIN≤TA≤TMAX	-	4.5	17	-	4.5	17	-	4.5	17	mV	
Ratio of Change in Reference Input Voltage to the Change in Cathode Voltage	$\Delta V_{REF}/\Delta V_{KA}$	IKA=10mA	$\Delta V_{KA}=10V-V_{REF}$	-	-1	-2.7	-	-1	-2.7	-	-1	-2.7	mV/V
			$\Delta V_{KA}=36V-10V$	-	-0.5	-2	-	-0.5	-2	-	-0.5	-2	
Reference Input Current	IREF	IKA=10mA, R1=10kΩ, R2=∞	-	1.5	4	-	1.5	4	-	1.5	4	μA	
Deviation of Reference Input Current Over Full Temperature Range	$\Delta I_{REF}/\Delta T$	IKA=10mA, R1=10kΩ, R2=∞, TA=Full Range	-	0.4	1.2	-	0.4	1.2	-	0.4	1.2	μA	
Minimum Cathode Current for Regulation	IKA(MIN)	VKA=VREF	-	0.45	1	-	0.45	1	-	0.45	1	mA	
Off -Stage Cathode Current	IKA(OFF)	VKA=36V, VREF=0	-	0.05	1	-	0.05	1	-	0.05	1	μA	
Dynamic Impedance	ZKA	VKA=VREF, IKA=1 to 100mA, f≥1.0kHz	-	0.15	0.5	-	0.15	0.5	-	0.15	0.5	Ω	

Note1

TMIN = -25°C, TMAX = +85°C

Test Circuits

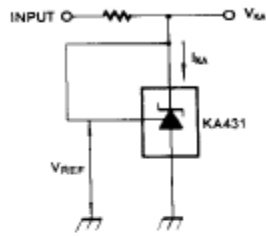

Figure 1. Test Circuit for $V_{KA}=V_{REF}$

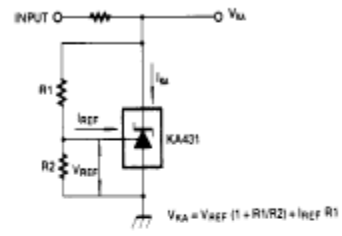

Figure 2. Test Circuit for $V_{KA} \geq V_{REF}$

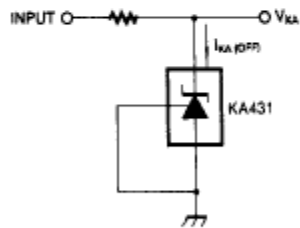

Figure 3. Test Circuit for $I_{KA(OFF)}$

Typical Performance Characteristics

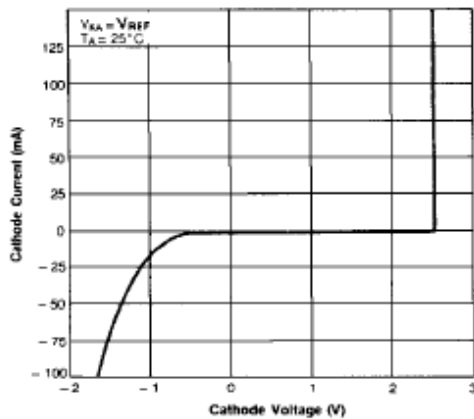

Figure 4. Cathode Current vs. Cathode Voltage

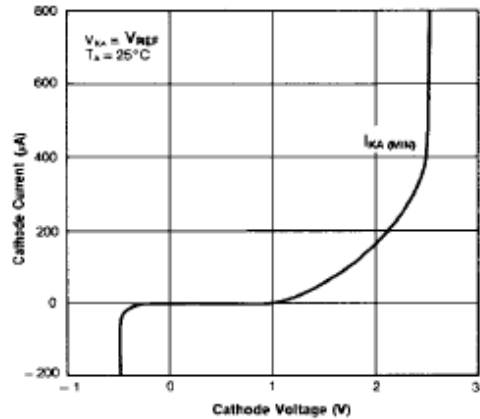

Figure 5. Cathode Current vs. Cathode Voltage

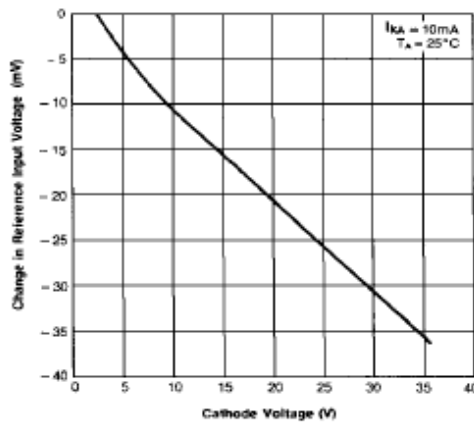

Figure 6. Change In Reference Input Voltage vs. Cathode Voltage

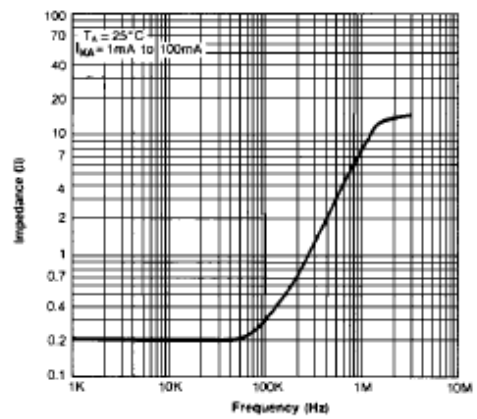

Figure 7. Dynamic Impedance Frequency

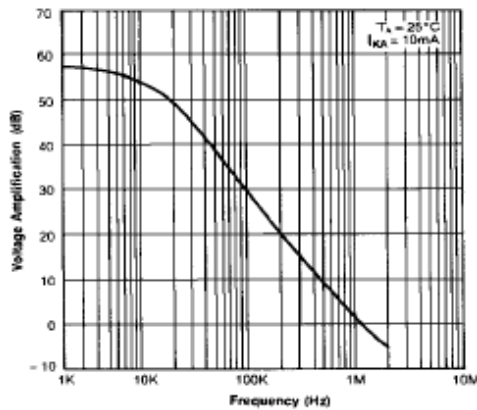

Figure 8. Small Signal Voltage Amplification vs. Frequency

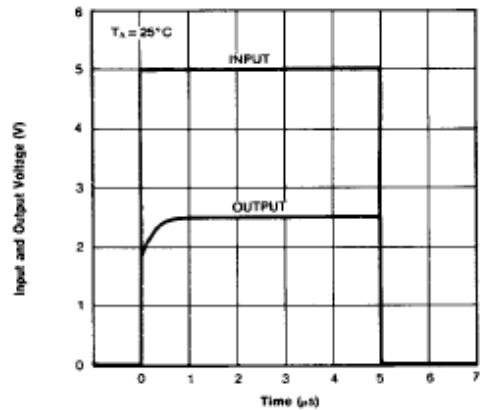

Figure 9. Pulse Response

Typical Performance Characteristics (Continued)

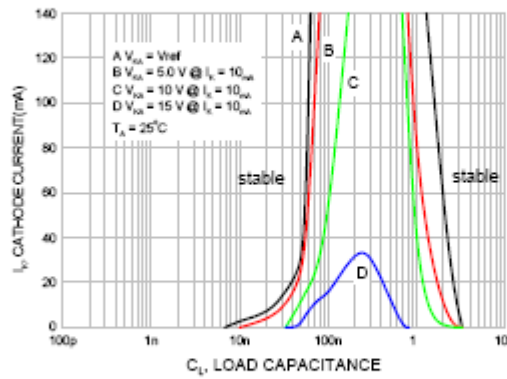

Figure 10. Stability Boundary Conditions

Typical Application

$$V_O = \left(1 + \frac{R_1}{R_2}\right) V_{ref}$$

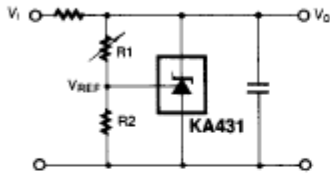

Figure 11. Shunt Regulator

$$V_O = V_{ref} \left(1 + \frac{R_1}{R_2}\right)$$

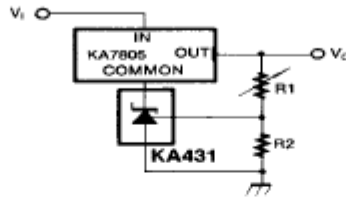

Figure 12. Output Control for Three-Ter minal Fixed Regulator

$$V_O = \left(1 + \frac{R_1}{R_2}\right) V_{ref}$$

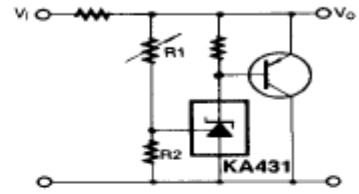

Figure 13. High Current Shunt Regulator

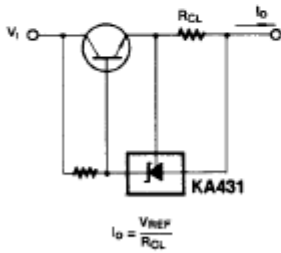

Figure 14. Current Limit or Current Source

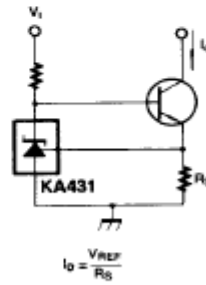

Figure 15. Constant-Current Sink

Mechanical Dimensions

Package

Dimensions in millimeters

TO-92 Bulk Type

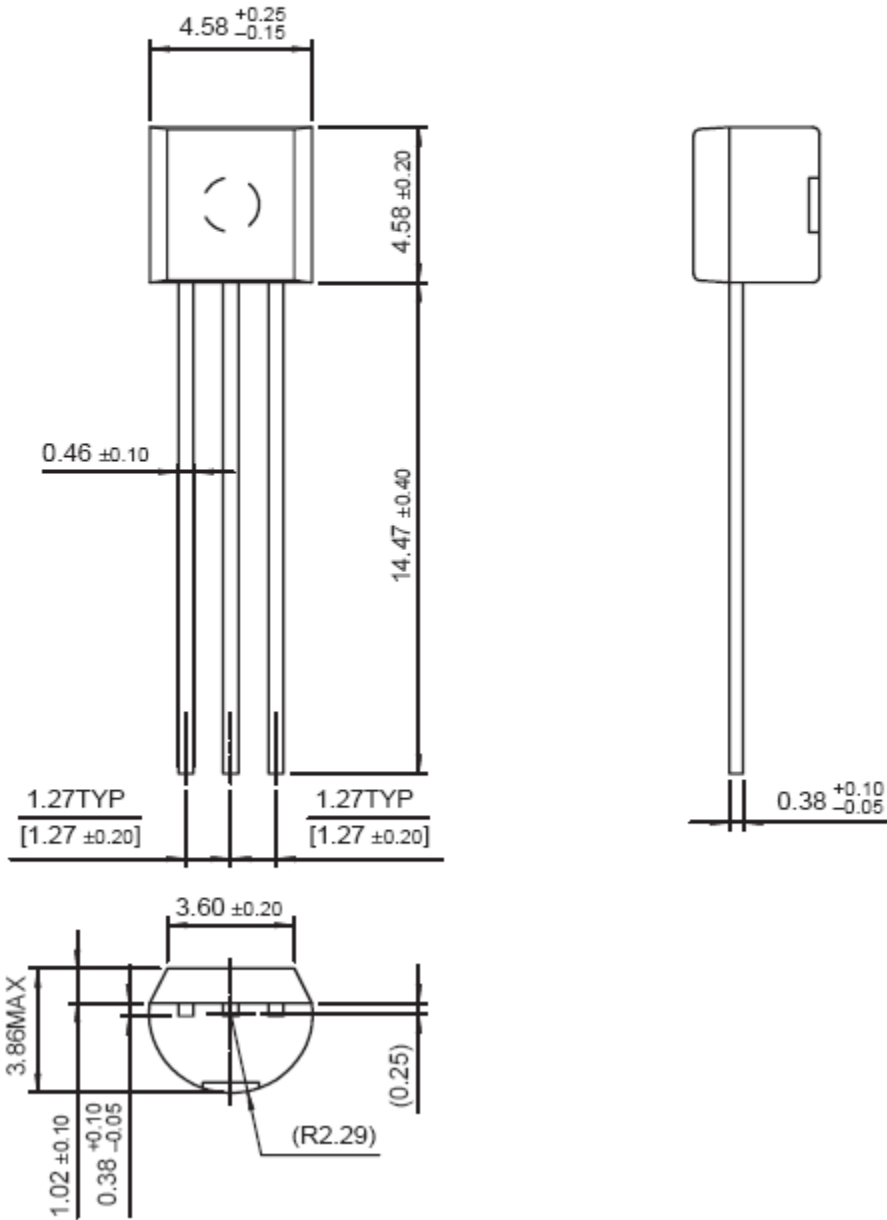

TO-92 Ammo Type & Tape And Reel Type

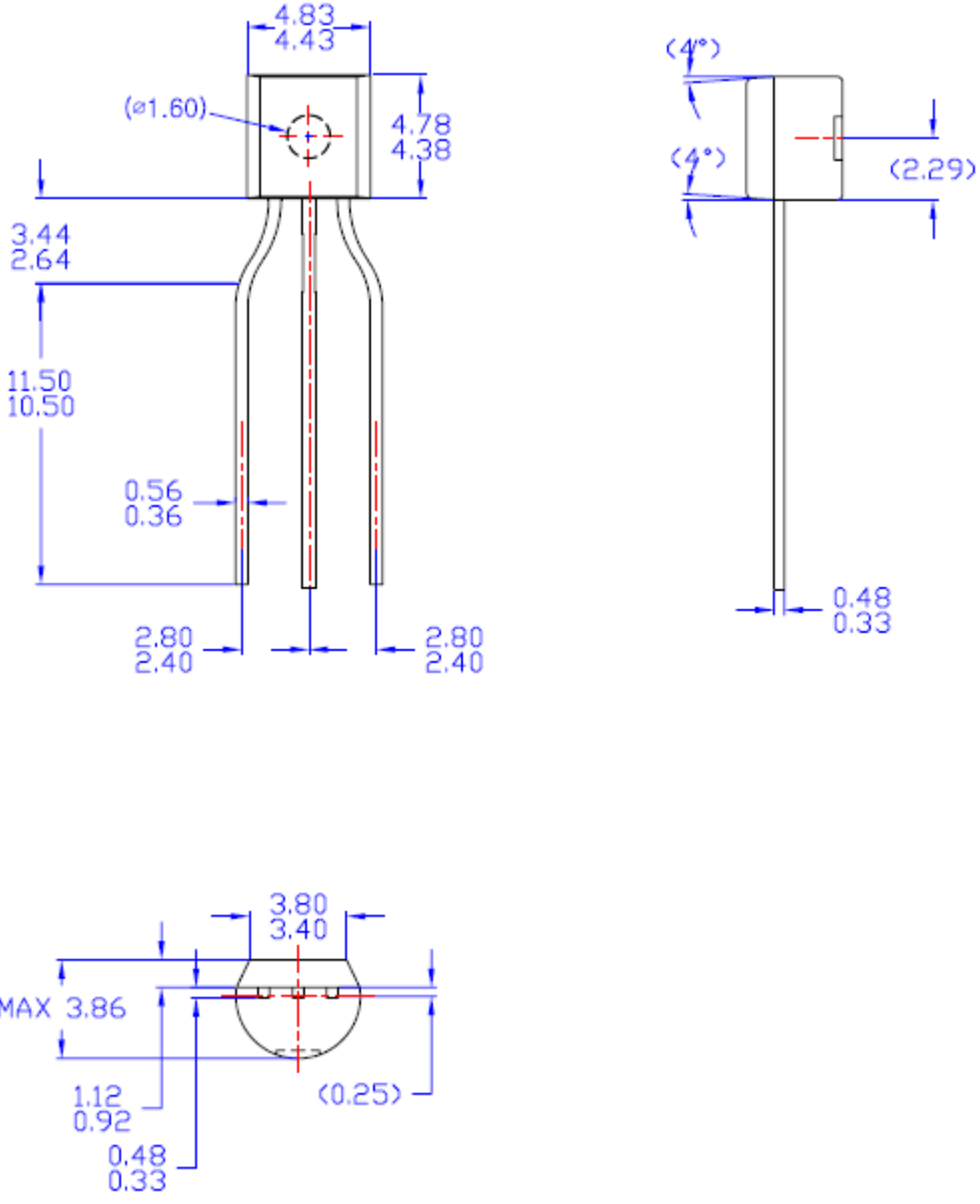

- NOTES:**
- A) THIS PACKAGE DOES NOT COMPLY TO ANY CURRENT PACKAGING STANDARD.
 - B) ALL DIMENSIONS ARE IN MILLIMETERS.
 - C) DRAWING CONFORMS TO ASME Y14.5M-1994
 - D) DIMENSIONS ARE EXCLUSIVE OF BURRS, MOLD FLASH, AND TIE BAR EXTRUSIONS.

FILE NAME: MKT-TO-92J61Z

Mechanical Dimensions (Continued)

Package

Dimensions in millimeters

8-DIP

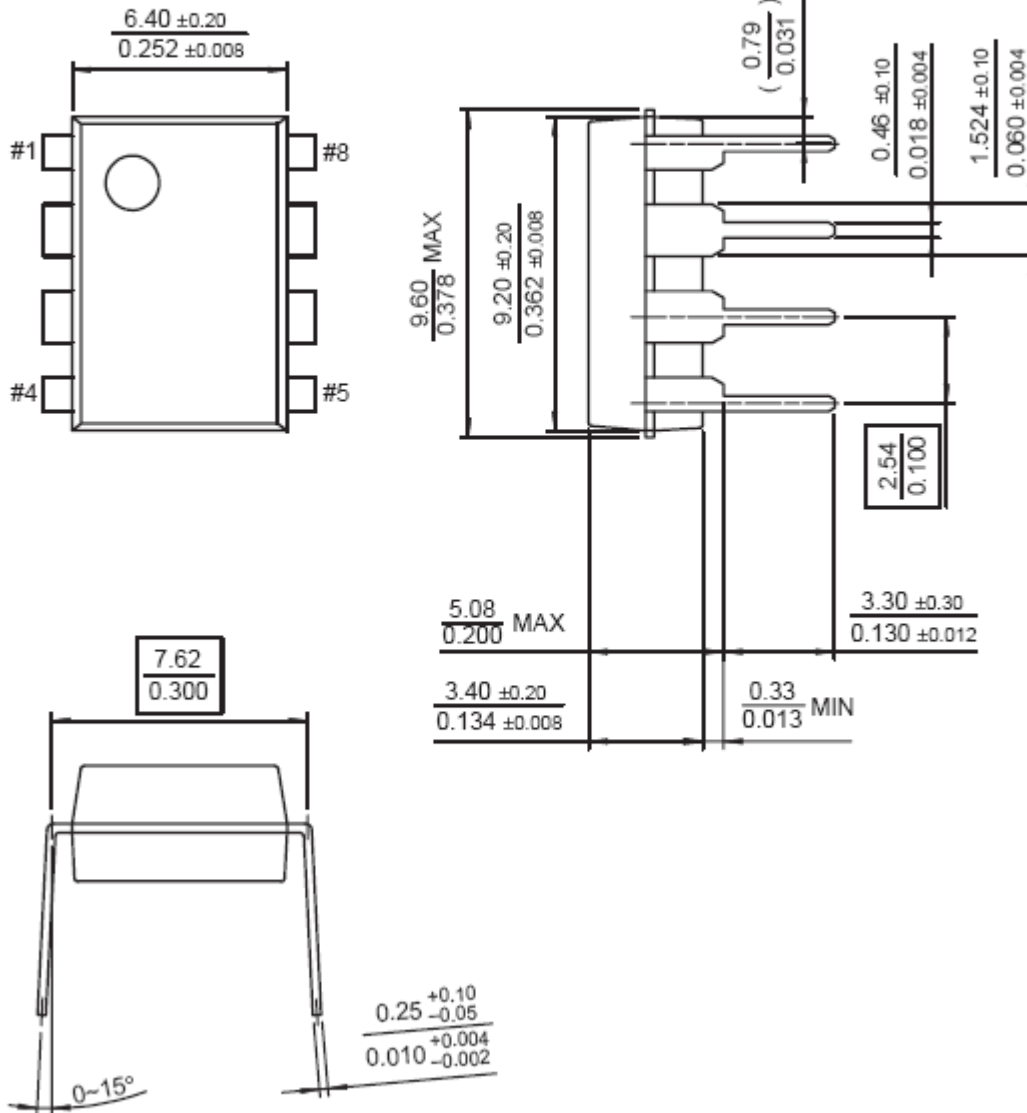

Mechanical Dimensions (Continued)

Package

Dimensions in millimeters

8-SOP

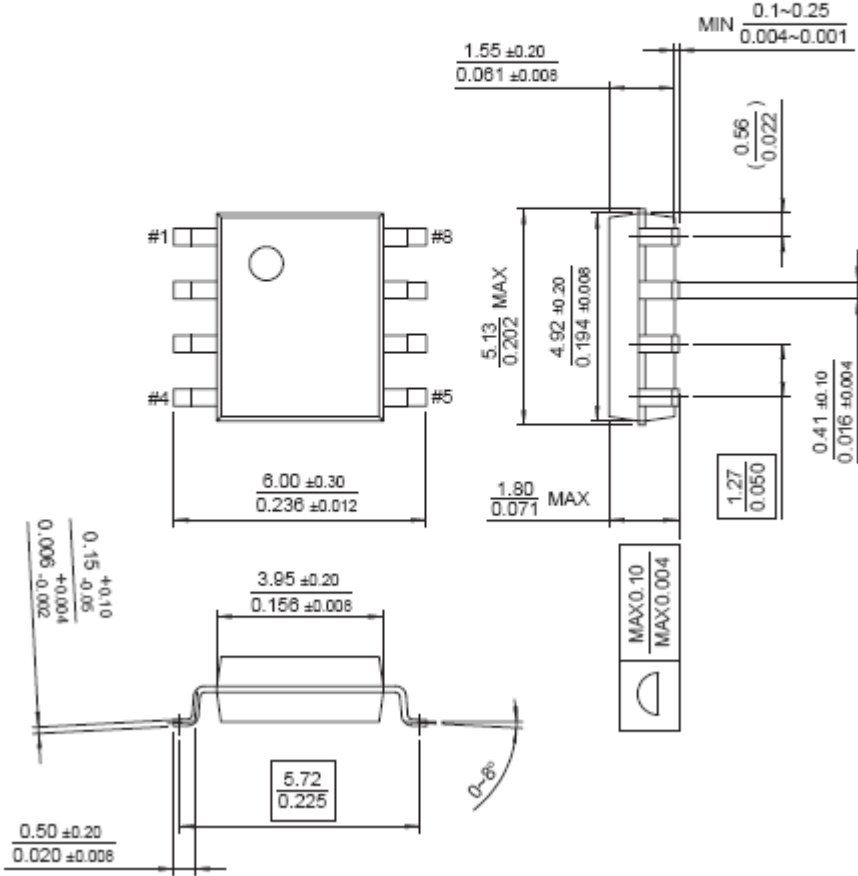

Ordering Information

Product Number	Output Voltage Tolerance	Package	Operating Temperature	Shipping
KA431LZ	0.5%	TO-92	-25 ~ +85°C	
KA431LD		8-SOP		
KA431AZ	1%	TO-92		
KA431AD		8-SOP		
KA431	2%	8-DIP		
KA431Z		TO-92		
KA431D		8-SOP		
KA431AZMTA	1%	TO-92		Ammo Pack
KA431AZTA				Tape & Reel
KA431AZTF				
KA431LZMTA	0.5%			Ammo Pack
KA431LZTA				Tape & Reel
KA431LZTF				
KA431ZMTA	2%			Ammo Pack
KA431ZTA				Tape & Reel
KA431ZTF				

- For information on tape & reel and ammo pack specifications, including part orientation and tape sizes, please refer to our tape and reel data, <http://www.fairchildsemi.com/products/analog/packaging/to92r.html>
-

DISCLAIMER

FAIRCHILD SEMICONDUCTOR RESERVES THE RIGHT TO MAKE CHANGES WITHOUT FURTHER NOTICE TO ANY PRODUCTS HEREIN TO IMPROVE RELIABILITY, FUNCTION OR DESIGN. FAIRCHILD DOES NOT ASSUME ANY LIABILITY ARISING OUT OF THE APPLICATION OR USE OF ANY PRODUCT OR CIRCUIT DESCRIBED HEREIN; NEITHER DOES IT CONVEY ANY LICENSE UNDER ITS PATENT RIGHTS, NOR THE RIGHTS OF OTHERS.

LIFE SUPPORT POLICY

FAIRCHILD'S PRODUCTS ARE NOT AUTHORIZED FOR USE AS CRITICAL COMPONENTS IN LIFE SUPPORT DEVICES OR SYSTEMS WITHOUT THE EXPRESS WRITTEN APPROVAL OF THE PRESIDENT OF FAIRCHILD SEMICONDUCTOR CORPORATION. As used herein:

1. Life support devices or systems are devices or systems which, (a) are intended for surgical implant into the body, or (b) support or sustain life, and (c) whose failure to perform when properly used in accordance with instructions for use provided in the labeling, can be reasonably expected to result in a significant injury of the user.
2. A critical component in any component of a life support device or system whose failure to perform can be reasonably expected to cause the failure of the life support device or system, or to affect its safety or effectiveness.

www.fairchildsemi.com